

# PITLINER

## INSTALLATION INSTRUCTIONS

SKU 711

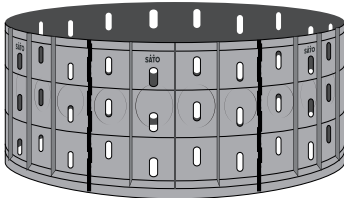
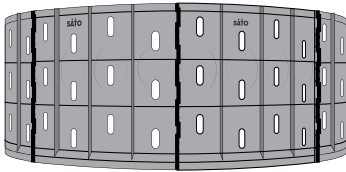
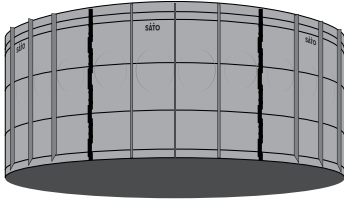

SKU 710

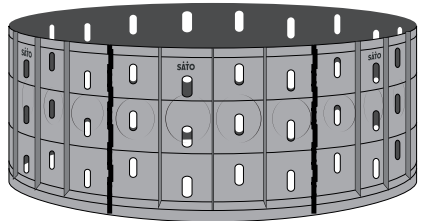
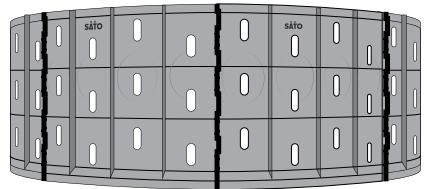
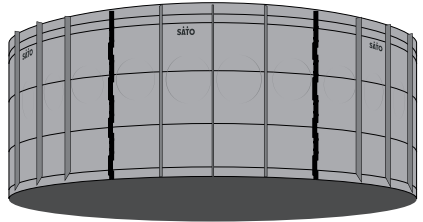

# SÄTO

A BETTER LIFE.  
EVERY DAY.

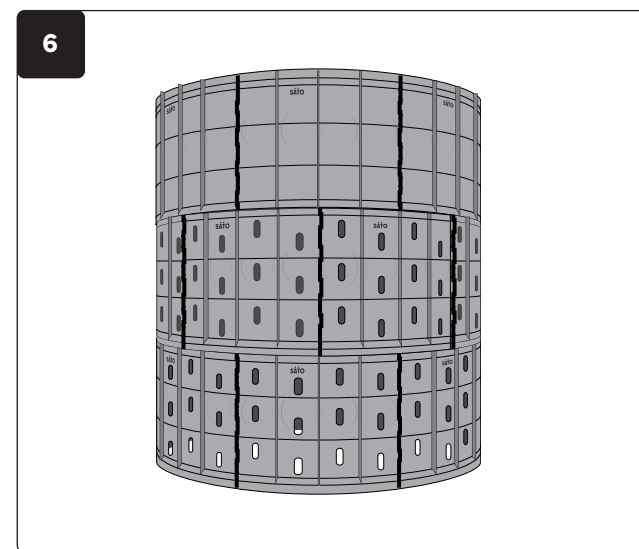
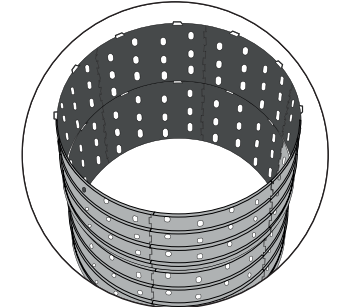
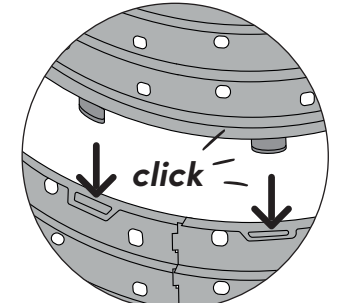
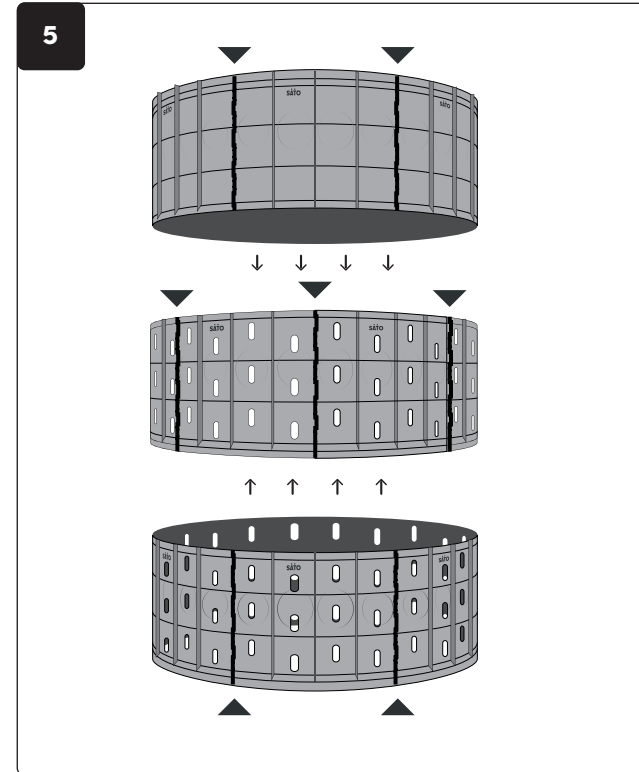
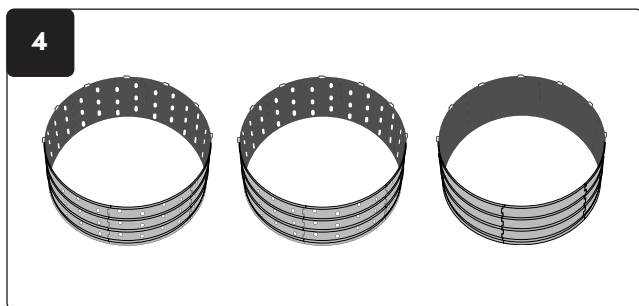
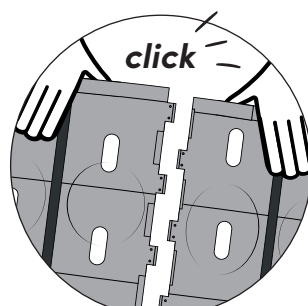
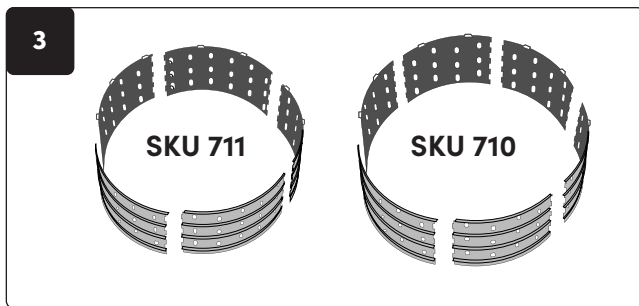
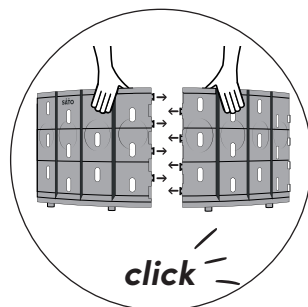
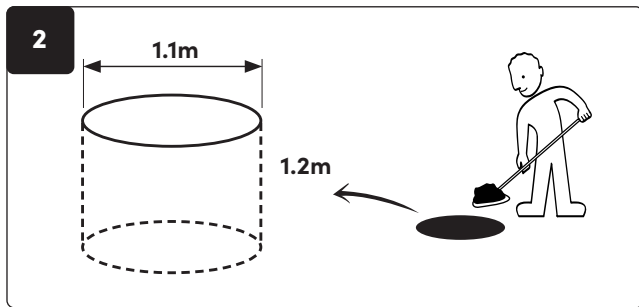
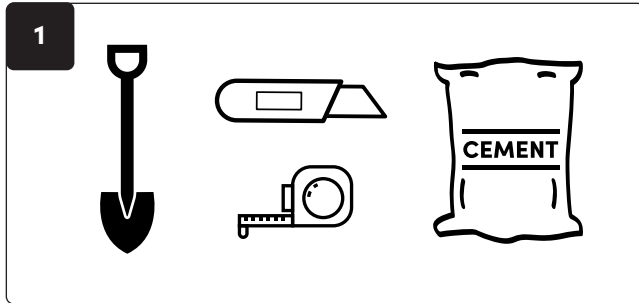

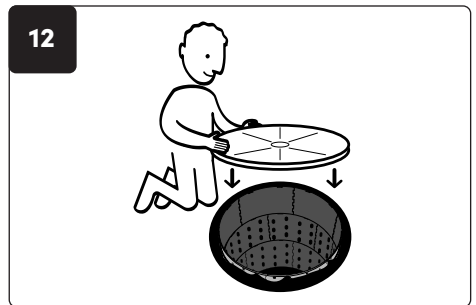
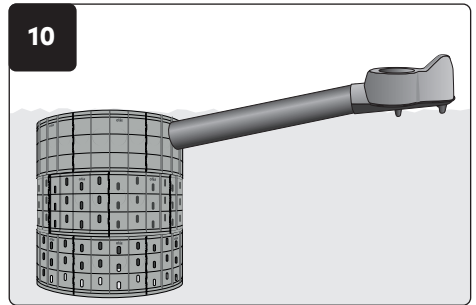
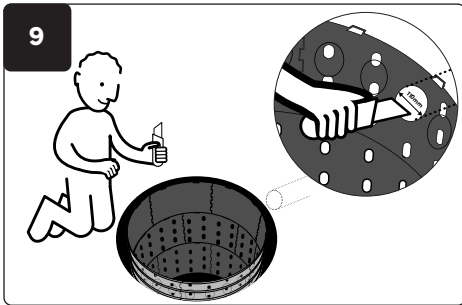
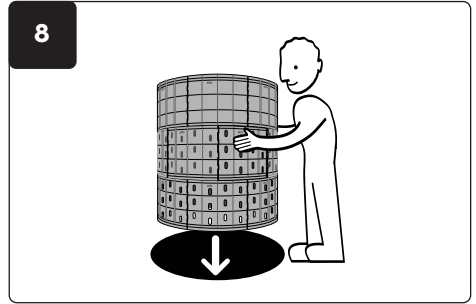
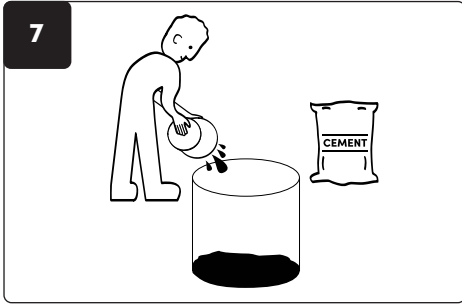

[www.sato.lixil.com/support](http://www.sato.lixil.com/support)

**Please call our Customer Experience Centre:**

India +1800 202 1626  
 Kenya 0800 722 233  
 Nigeria 0800 123 5400  
 Uganda 0800 200 457  
 Tanzania 0800 120 076  
 Rest of Africa +254 800 722 233

Monday to Friday between 9am-6pm  
 Monday to Friday between 9am-6pm  
 Monday to Friday between 9am-6pm  
 Monday to Friday between 9am-6pm  
 Monday to Friday between 9am-6pm  
 Monday to Friday between 9am-6pm  
 or Saturday between 9am and 1pm

**SATO**  
 A BETTER LIFE.  
 EVERY DAY.

Email: [sato@lixil.com](mailto:sato@lixil.com)

Issue 01\_1st April 2024